

GPD515/G5 Software Option (VSG114676) Part Number: CIMR-G5MXXXXXF-015 ⁽¹⁾

With this factory-installed FLASH software, the GPD515 / G5 becomes a configurable drive.

User Configurable software enhances the standard drive software with embedded functions. The drive may be operated as a standard off the shelf drive or may be configured to utilize the embedded functions. The functions can be configured to create the necessary control logic for many speed or torque control applications. It is possible to reduce the need for external control modules and PLC's. Whole control systems may be integrated into a stand-alone GPD515 / G5 drive.

With this software, it is possible to read in information and output it into other functions from the following sources;

- ✓ All analog inputs
- ✓ All PG options
- ✓ Drive speed output
- ✓ Drive torque output
- ✓ Drive Hertz output
- ✓ Internal MOP
- ✓ Parameters

These sources can be input into the following functions that perform operations to change and control them. The following operations are available;

- ✓ Add, subtract, multiply and divide
- ✓ Change polarity

- ✓ Compare sources
- ✓ Absolute value
- ✓ PID
- ✓ Diameter calculator
- ✓ Scale information
- ✓ Switch between sources

The outputs from these functions can be connected to other functions or used to control the drive. The drive functions can be used to write information directly to the following drive controls;

- ✓ Analog outputs
- ✓ Speed reference
- ✓ Torque reference
- ✓ Multi-function outputs
- ✓ Digital Operator Monitors

This software provides the user the flexibility to configure their own logic and to change it when needed. It is one software flash that could replace many.

To better understand what this software can do it is necessary to understand the functions. It is also necessary to understand how to enter the configuration into the drive. The following sections of this manual will explain how to use and setup the functions.

This document is an addendum to Technical Manual TM4515, listing the effect of this software on the parameters in the drive and function descriptions in the manual.

⁽¹⁾ XXXXX refers to the base Model Number of the drive in which the software is installed.

Function Blocks - Quick Reference

Source

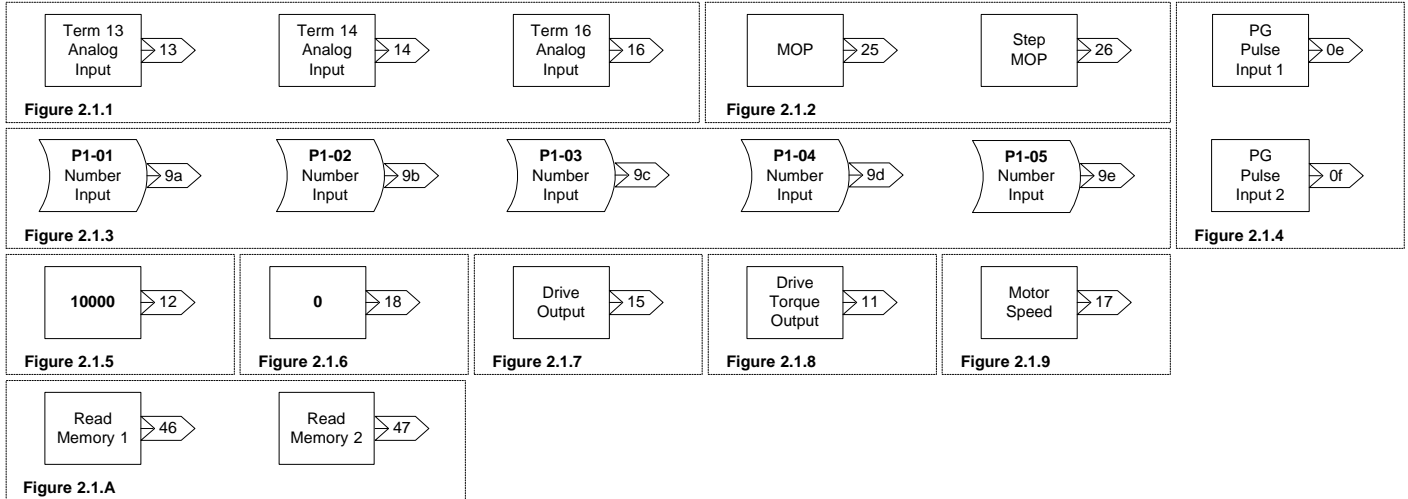

Operation

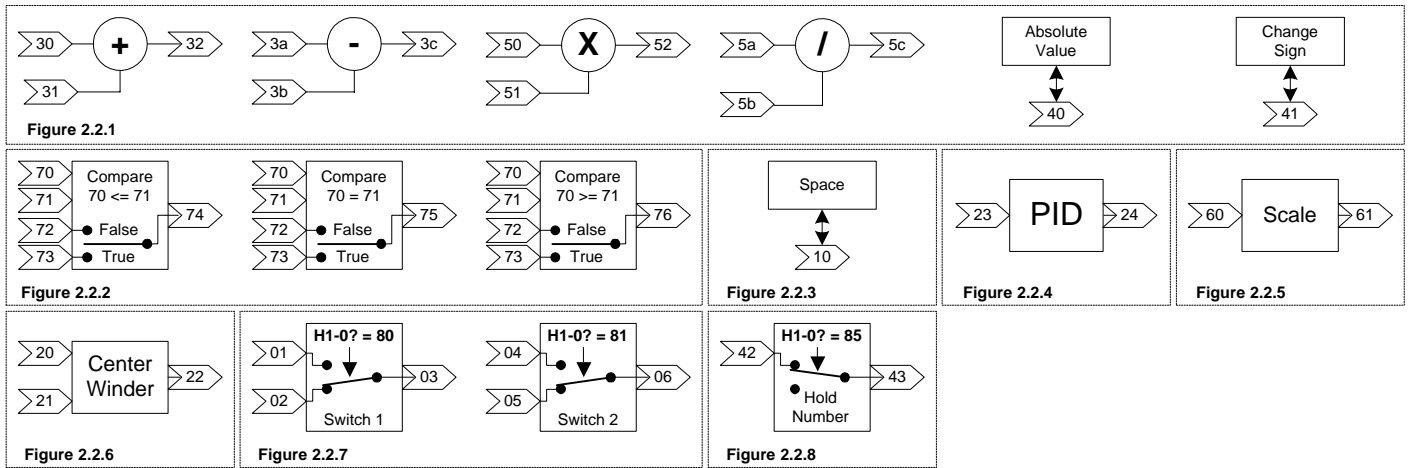

Drive

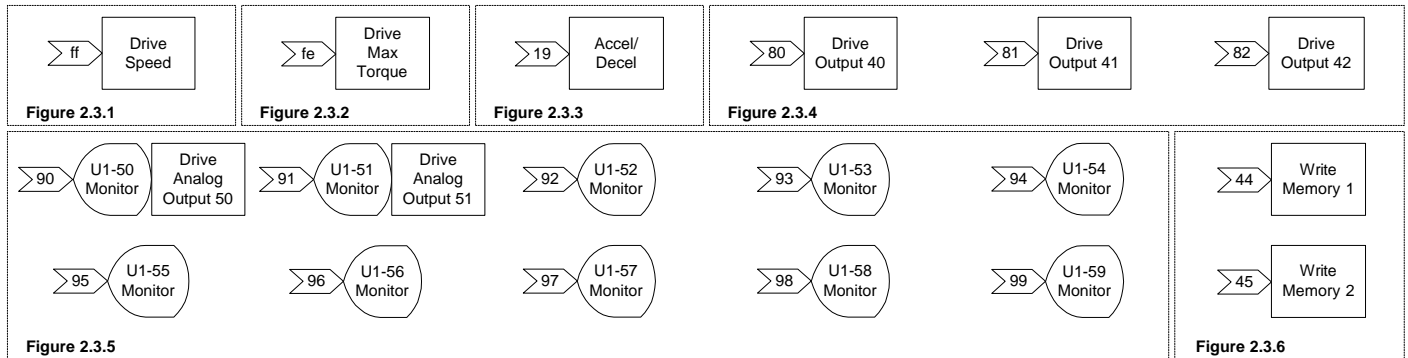

Function Block Setup - Quick Reference

Sheet 1 of 2

2.1 Sources			Connections		Setup
Figure	Description	Information	Input	Output	
2.1.1 Analog Inputs	Analog Input 13	Terminal 13		13	Terminal 13 can not be reassigned
	Analog Input 14	Terminal 14		14	Terminal 14 – H3-09 = 20: Eliminator T-14
	Analog Input 16	Terminal 16		16	Terminal 16 – H3-05 = 21: Eliminator T-16
2.1.2 MOP / Step MOP	MOP	P2-02 = MOP Rate / second P2-03 = MOP Max Percent P2-04 = MOP Min Percent P2-05 = MOP Rst Percent		25	H1-xx = 82: MOP UP H1-xx = 83: MOP DOWN H1-xx = 84: MOP RESET
	Step MOP	P2-06 = MOP Step Rate		26	
2.1.3 Number Inputs	P1-01	Range 0 to 65535		9A	
	P1-02	Range 0 to 65535		9B	
	P1-03	Range 0 to 65535		9C	
	P1-04	Range 0 to 65535		9D	
	P1-05	Range 0 to 65535		9E	
2.1.4 Pulse Inputs	PG Channel 1	F1-01 = Pulses Per Rev.		0E	PG Option Card Required (PG-X2 or PG-W2)
	PG Channel 2	P2-01 = Pulses input at 100 % inverter speed (Range 0 to 65535)		0F	PG-W2 Option Card Required
2.1.5 10000	100 % Reference	10000 output value		12	
2.1.6 0	0 % Reference	0 output value		18	
2.1.7 Drive Output	Output Reference	Percentage of Maximum Frequency 0-10000 output value		15	
2.1.8 Torque Output	Torque Reference	Percentage of 100.00 Percent Torque 0-40000 output value		11	
2.1.9 Motor Speed	Motor Speed Percentage	Available in PG and Vector modes only		17	
2.1.A Read Memory	Read Memory 1	Reads the value written into memory with the associated write memory.		46	Reads Write Memory 1
	Read Memory 2			47	Reads Write Memory 2

2.2 Operations			Connections		Information / Equation
Figure	Description	Information	Input	Output	
2.2.1 Math	Addition	Input Value	30	32	30 + 31 = 32
		Input Value to add	31		
	Subtraction	Input Value	3a	3c	3a - 3b = 3c
		Input Value to subtract	3b		
	Multiplication	Input Value	50	52	(50 x 51) / 10000 = 52
		Input Value to multiply by	51		
	Division	Input Value	5a	5c	(5a x 10000) / 5b = 5c
		Input Value to divide by	5b		
Absolute Value	Same Input / Output Connector		40	Absolute Value of X	
Change Sign	Same Input / Output Connector		41	X times -1	

Function Block Setup - Quick Reference

Sheet 2 of 2

2.2 Operations			Connections		Information / Equation		
Figure	Description	Information	Input	Output			
2.2.2 Compare	Compare input 70 to input 71	1 st Value	70				
		Compared to 1 st Value	71				
		Value if True	73				
		Value if False	72				
		Output less or equal				74	70 <= 71 (True: 74 = 73) (False: 74 = 72)
		Output equal				75	70 = 71 (True: 75 = 73) (False: 75 = 72)
Output greater or equal		76	70 >= 71 (True: 76 = 73) (False: 76 = 72)				
2.2.3 Space	Enter Spaces	Used to enter spaces into a configuration		10			
2.2.4 PID	PID 23 = Error input	B5-02 PID Gain = P Gain	23	24	B5-01 PID Mode = Disabled		
		B5-03 PID I Time = I Bld Rate					
		B5-04 PID I Limit = I Limit					
		B5-05 PID D Time = D Rate					
		B5-06 PID Limit = Output Limit					
2.2.5 Scale	Scale	P1-08 = Scale Multiplier	60	61	((60 X P1-08) / P1-09) + P1-10 = 61		
		P1-09 = Scale Divisor					
		P1-10 = Scale Bias					
2.2.6 Center Winder	Calculate Diameter with ratio output	Line Speed Ref input	20	22	P1-06 = Diameter Filter Time P1-07 = Diameter Build Ratio		
		Diameter Filter Output					
		Motor Speed Ref input	21				
2.2.7 Internal Switches	Switch 1	Normally Open	01	03	Terminal ? - H1-01 to 06 = 80: Switch 1 DI		
		Normally Closed	02				
	Switch 2	Normally Open	04	06	Terminal ? - H1-01 to 06 = 81: Switch 2 DI		
		Normally Closed	05				
2.2.8 Number Hold	Hold last input value	Outputs input value until the Hold is activated causing it to hold the last value read..	42	43	Terminal ? - H1-01 to 06 = 85: Number Hold		

2.3 Drive			Connections		Information / Equation
Figure	Description	Information	Input	Output	
2.3.1 Drive Speed	Frequency Reference to Drive	Controls the drives output frequency Range 0 to +/- 10000	ff		E1-04: Max Frequency Limits the drive output
2.3.2 Drive Max Torque	Torque Reference	Controls the Max output torque from the drive. Flux vector control only. Same as changing L7-01 and L7-02.	fe		P2-10 = Max Torque Ref (limit) Sets Max torque limit L7-01: Fwd = L7-02: Rev
2.3.3 Accel / Decel	Accel / Decel	Changes the acceleration and deceleration time. Accel = Decel	19		Accel Time = (19 x C1-01) / 10000 Decel Time = (19 x C1-02) / 10000
2.3.4 Drive Outputs	Contact Output 9	Connects terminal 9 to 10	80		H2-01 = 40: CONNECTION 80
	Trans Output 25	Sinks terminal 25 to 27	81		H2-02 = 41: CONNECTION 81
	Trans Output 26	Sinks terminal 26 to 27	82		H2-03 = 42: CONNECTION 82
2.3.5 Analog / Monitor Outputs	Monitor 1 (U1-50)	Information can be passed to analog output terminals 21 and 23	90		H4-01 or H4-04 = 50: Case Monitor 1
	Monitor 2 (U1-51)		91		H4-01 or H4-04 = 51: Case Monitor 2
	Monitor 3 (U1-52)	92	Monitor Value = Input Value / 10		
	Monitor 4 (U1-53)	93			
	Monitor 5 (U1-54)	94			
2.3.6 Write Memory	Write a value into the Number Read registers	Store numerical data into running memory. Two registers provided.	44		Number Write 1
			45		Number Write 2

1.0 Configuring The Function Blocks

User Configurable software allows the GPD515/G5 drive to be configured to a specific application. This is accomplished by internal drive functions that may be connected to provide the logic required. For the purposes of understanding and developing logic the internal functions have been reduced to function blocks. The function block diagrams indicate how they can be connected.

Some functions have required setup as multi-function selections to operate. Many functions have associated parameters to provide control. Developing a configuration involves choosing the functions required, connecting them for the required logic and setting the parameters that control the functions.

1.1 Developing a Configuration

Function blocks are simple block diagrams that indicate their function and how they are connected. The arrow like icons used for the input and output connectors indicate the direction information is moving. A connector number is shown within these icons. Figure 1.1 shows the anatomy of the three categories of functions as function blocks.

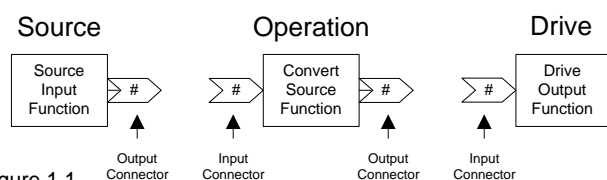

Figure 1.1

Using function blocks provides a way to develop configurations so they may be understood. From Figure 1.1 it is possible to see how the function blocks may be connected. Figure 1.2 demonstrates how the function blocks are connected.

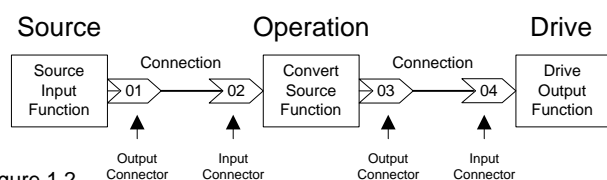

Figure 1.2

In figure 1.2 a source input function sends information to the output connector 01. The information is passed through the connection to the input connector 02 of the operation. The operation reads this information and converts it sending the result to the output connector 03. The information is passed through the connection to the input connector 04. The drive output function directs the information to control the drive. All configurations follow this example. There can be more complex configurations with more operations but the basics are the same. The information starts at a source. It is connected to the operations necessary to convert and control it. The information is then passed to the drive.

Developing a configuration for a drive requires selecting a data source and directing it through operations changing it to information that will provide the proper drive control and then

connecting it to the drive function. Configurations can be complex with many sources and operations or as simple as selecting a source reference and connecting it to the drive function.

Once a configuration has been developed using the function blocks to convert source information, it is necessary to enter the configuration into the drive. Entering the configuration into the drive requires generating a configuration list. This list is a record of all connections starting with the beginning information and following the operations in the manner that they must be executed until the information is connected to the drive functions required.

1.2 Configuring The GPD515

Using figure 1.2 a configuration list can be generated by starting at the source output connector 01 and recording the number within it. Next record the number within the input connector 02 that it connects. Follow the information path in the manner that it must be executed. This will yield – 01,02,03,04. The configuration list of connector numbers must be entered into the drive in this sequence.

This software reserves twenty-two User Parameters for the purpose of configuring the GPD515 / G5 drive. The User Parameters are located under the Initialize menu option. Parameters A2-01 through A2-10 remain unchanged serving their standard function. Parameters A2-11 through A2-32 are used for configuring the drive. Configuring the drive requires entering the configuration list into these parameters.

To enter the configuration list into the drive start at A2-11 and enter the first two-connector numbers or the first connection. Enter the next two-connector numbers or the second connection in the next parameter A2-12 and continue this until the complete configuration list has been entered.

Using the configuration list developed for figure 1.2, User Parameter A2-11 will be set to 0102, which are the numbers of the first connection. A2-12 will be set to 0304, which are the numbers of the second connection. When the drive is returned to operation the configuration list will be executed in the sequence that it was entered. The sequence ends at the first 00 connector number, which is the default number for the user parameters. The User Parameter connector numbers are read in the sequence that they are entered. Each connector number results in an operation. Input connectors store the information that is connected to them. Output connectors execute a function to read the stored input connector information or to read information from the drive then the associated function is executed converting the information sending it to the output connector.

1.3 Setup of Functions

Some functions require being selected in the standard drive parameters before they will function. Many functions have parameters and multi-function inputs associated with them. Section 2 explains the functions, their setup and controls. This information can also be found in the quick reference information. The parameters used for these purposes should be set when the configuration is entered into the GPD515 / G5. Only the parameters required for the current configuration need to be setup.

1.4 Configuring Examples

This software may be configured just using the quick references. The following examples will demonstrate that it is just a matter of selecting the needed functions and connecting them together. Once the configuration is finished just record the connector numbers in the sequence that starts at the source information and follows it through the operations in the manner that it must be converted until it is sent to the drive. Then input the connector numbers into the drive.

Example 1.4.1:

This configuration will provide a speed reference to the drive and a scaled display monitor for the machine operator.

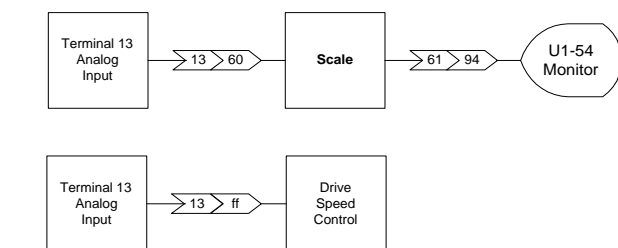

Figure 1.4.1

<p>Configuration List 13,60,61,94,13,ff, 00</p> <p>Configure the Drive A2-11 = 1360 A2-12 = 6194 A2-13 = 13ff A2-14 = 00XX</p> <p>XX = Don't Care</p>

The scaling parameters must be set to control the value displayed by the monitor.

Example 1.4.2:

This configuration uses 2 multi-function inputs to select between the 3 analog inputs to be used as the speed reference.

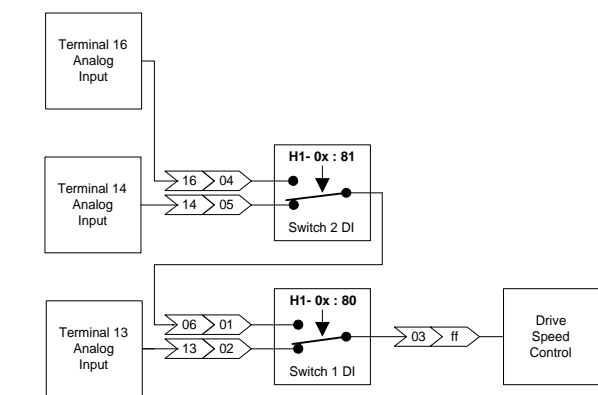

Figure 1.4.2

<p>Configuration List 16,04,14,05,06,01,13,02,03, ff, 00</p> <p>Configure the Drive A2-11 = 1604 A2-12 = 1405 A2-13 = 0601 A2-14 = 1302 A2-15 = 03ff A2-16 = 00XX</p> <p>XX = Don't Care</p>
--

The multi-function and analog inputs must be setup. The drive will use terminal 13 as a reference with both switches off. When switch 1 is on via the multi-function input, terminal 14 becomes the reference. When both switches are on via the multi-function inputs, terminal 16 becomes the reference.

1.5 Advanced Topics / Examples

The configuration entered in the A2 User Parameters is a sequence of numbers that are read back and executed by connector numbers. Each A2 parameter contains one connection point or two connector numbers. Each connector number must be two digits. When the connector number is a single digit a 0 must be added to make it two. The leading zeros must be entered.

When a connector is read into the drive the function it represents is executed. Upon completion the next connector or two digit number is read and executed. This continues until a 00 is read or until all 22 A2 parameters or all 44 connector numbers have been executed.

The connectors are always read in sequence starting at the beginning and finishing at the end. The complete sequence is read each scan. The process starts over again on the next scan.

All operation input connectors store the connected input value without changing it. Because of this it is possible to connect values to all operation inputs before entering the output connector number into the sequence. When an operation output connector is read and executed the current stored input or last read values will be used and a new value is calculated and output. This must be considered when using an operation more than one time. Each time it is used all the inputs must only be in the sequence one time before the output is entered. After the output is entered it is possible to reuse the operation inputs but the output must be entered again before the end of the configuration sequence.

It is also possible to reduce the numbers required in the sequence by only entering an output one time when it is connected to several inputs. Once the output has been executed, the current value that will be passed to all input connectors is unchanged until the next output is executed. Therefore all input connectors that connect to an output may be entered into the configuration sequence after the output and before the next output. Outputs change the current value that will be passed. Inputs do not change the current or last output value.

Despite the flexibility provided with this software there are some configurations that may not be possible. The following examples demonstrate what has been covered in this section.

Example 1.5.1: This will function properly

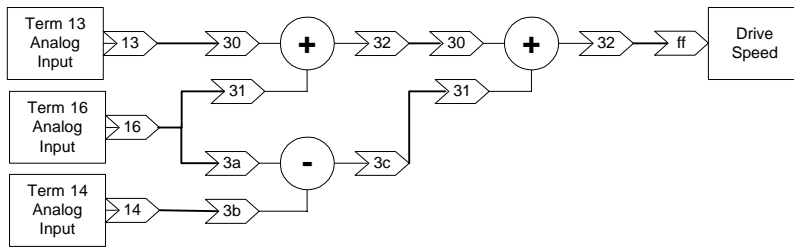

Figure 1.5.1

Configuration List
13,30,16,31,16,3a,14,3b,32,30,3c,31,32,ff

Configure the Drive
A2-11 = 1330 A2-15 = 3230
A2-12 = 1631 A2-16 = 3c31
A2-13 = 163a A2-17 = 32ff
A2-14 = 143b A2-18 = 00XX

XX = Don't Care

Example 1.5.2: This will not function as intended

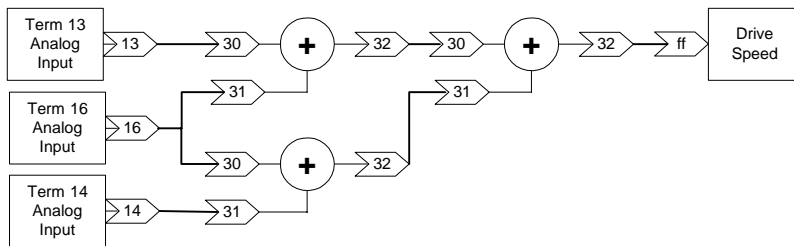

Figure 1.5.2

Configuration List
13,30,16,31,16,30,14,31,32,30,32,31,32,ff

Configure the Drive
A2-11 = 1330 A2-15 = 3230
A2-12 = 1631 A2-16 = 3231
A2-13 = 1630 A2-17 = 32ff
A2-14 = 1431 A2-18 = 00XX

XX = Don't Care

In this example output 32 will provide the value from the last execution to both connected inputs.

Example 1.5.3 This will function properly

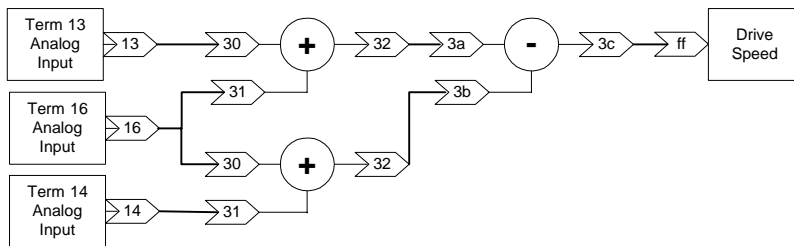

Figure 1.5.3

Configuration List
13,30,16,31,32, 3a,16,30,14,31,32,3b,3c,ff

Configure the Drive
A2-11 = 1330 A2-15 = 1431
A2-12 = 1631 A2-16 = 323b
A2-13 = 323a A2-17 = 3cff
A2-14 = 1630 A2-18 = 00XX

XX = Don't Care

Example 1.5.4 Figure 1.5.1 above can be reduced as shown

Reduced List Figure 1.5.1
13,30,16,31,3a, 14,3b, 32, 30, 3c, 31, 32, ff

Configure the Drive
A2-11 = 1330 A2-15 = 303c
A2-12 = 1631 A2-16 = 3132
A2-13 = 3a14 A2-17 = ff00
A2-14 = 3b32 A2-18 = XX

Figures 1.5.2 and 1.5.3 cannot be reduced. The common output 16 must be input to the addition function for each execution since a function will use the last value input for each execution. If output 16 was connected to input 31 on both addition functions it could be reduced since input 31 would remain the same for both executions.

2.0 Function Blocks

2.1 Source Function Blocks

Source functions are used to output information into the function block configuration. All configurations will begin with a source. All source information is expressed as a number, which is a percentage of their function. The normal range is from 0 to +/- 100.00 percent. The actual value used for 100.00% is 10000. This must be understood to convert information within a configuration.

2.1.1 Analog Inputs

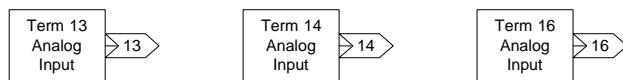

Figure 2.1.1

Analog Input functions provide information from the analog input terminals. The source output connectors are numbered the same as the corresponding analog input terminal. Terminals 14 and 16 must be setup. The number provided at the output connector is controlled by the standard H3 parameters associated with analog inputs and is expressed as a percentage of the maximum frequency. This value can be bi-polar when the analog input is set to be. With all associated analog constants set at default values the output range is from 0 to 10000.

Function	Controls	Range	Default	Setup
Terminal 14	Analog input terminal 14			H3-09 = User Cfg Term 14
Terminal 16	Analog input terminal 16			H3-05 = User Cfg Term 16

Terminal 14 analog input is defaulted as a 4 to 20ma input. To convert this to a voltage input jumper J1 located directly above terminal 13 on the control board must be opened.

2.1.2 MOP (Motor Operated Pot)

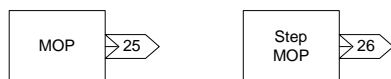

Figure 2.1.2

MOP functions simulate a motor operated pot and can be used to control the value output. A maximum and a minimum parameter control the range of the output limiting it to +/- 1000 % or an actual output value of +/- 100000. Separate multi-function inputs control increasing, decreasing and resetting the value to a preset. When the multi-function inputs have been setup for the MOP, turning the MOP up input on will increment the output value at a definable rate. The same is true for the MOP down except the output value decrements. The output value will only change when the MOP multi-function input control is on. When the MOP reset input is on, the output value will reset to a preset value.

The Step MOP uses the same controls as the MOP. This function will change the output value by a definable step for each transition from off to on of the MOP Up or MOP Down Controls. A maintained input will only result in the output changing the value of one step. The multi-function input control must be off for a minimum of 5ms before the next step will execute.

Function	Controls	Range	Default	Setup
MOP	P2-02 = MOP Rate / second	0.00% to 100.00%	0.00%	H1-xx = 82: MOP UP H1-xx = 83: MOP DOWN H1-xx = 84: MOP RESET
	P2-03 = MOP Max Percent	0 to 1000%	100%	
	P2-04 = MOP Min Percent	-1000% to 100%	0%	
	P2-05 = MOP Rst Percent	-1000% to 1000%	0%	
Step MOP	P2-06 = MOP Step Rate / step	0.00% to 100.00%	0.00%	

2.1.3 Number Inputs

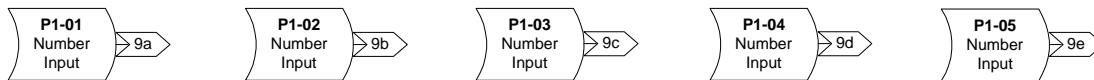

Figure 2.1.3

Number Input functions output the parameter information into other functions. The value can range from 0 to 65535. The number to input must be set in the associated P1 parameter.

Function	Controls	Range	Default	Setup
P1-01	Number output	0 to 65535	0	P1-01 = Desired number
P1-02				P1-02 = Desired number
P1-03				P1-03 = Desired number
P1-04				P1-04 = Desired number
P1-05				P1-05 = Desired number

2.1.4 Encoder Pulse Inputs

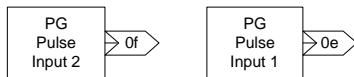

Figure 2.1.4

Encoder Pulse Input functions output information from PG option cards into a configuration. There are two input channels. Channel 1 is available with all PG option cards. Channel 2 is only available with a PG-W2 option card.

Channel 1 defaults to using F1-01: PG Pulses/Rev and E2-04: Motor Poles to scale the output to the maximum frequency. The output value will range from 0 to 10000. The output is positive regardless of encoder direction. Access to F1-01 has been enabled for open loop control. E2-04 remains defaulted to 4 poles and can only be changed in flux vector control mode.

Channel 2 requires a PG-W2 option card. The data from channel 2 is converted in a percentage of the P2-01: Max Pulses In 2. The output will range from 0 to +/-10000. The output polarity reflects the encoder direction.

Function	Controls	Range	Default	Setup
PG Channel 1	F1-01: PG Pulses/Rev.	0 to 60000	1024	Requires a PG option card
	E2-02: Motor Poles	2 - 48	4	Flux Vector control only
PG Channel 2	P2-01: Max Pulses In 2	0 to 65535	30720	Requires a PG-W2 card

2.1.5 10000

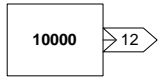

Figure 2.1.5

The 10000 function outputs the number 10000 to all connected functions.

2.1.6 0

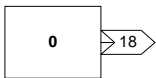

Figure 2.1.6

The 0 function outputs the number 0 to all connected functions.

2.1.7 Drive Output

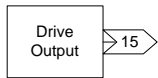

Figure 2.1.7

The Drive Output function outputs the percentage of the maximum frequency setting that the drive is outputting. The value output can range from 0 to 10000.

2.1.8 Drive Output Torque

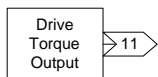

Figure 2.1.8

The Drive Output Torque function outputs the percentage of the drive output torque. The value output can range from 0 to the maximum torque setting.

2.1.9 Motor Speed Reference

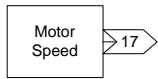

Figure 2.1.9

The Motor Speed function outputs the calculated motor speed as a percentage of the maximum frequency setting. The value output can range from 0 to 10000.

2.1.A Read Memory

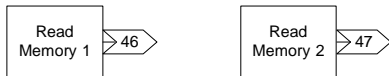

Figure 2.1.A

Read Memory functions output the value stored in memory by the corresponding Write Memory function. This memory is volatile and stored values will be lost when the drive is turned off. This may be used to retrieve old values from the previous scan when the read function precedes the write function in the configuration. It can also be used to store a value from a function output allowing the function to be ended and used again later in the configuration. This value can be connected where required within the same scan.

2.2 Operations

Operation function blocks are used to change the data that is input. Some operations may be needed more than one time in a configuration. This is only possible for the operations that indicate it. When this is done all inputs of the operation must have the information required present before the output is executed for each instance. This is important when several operations are connected together.

2.2.1 Math

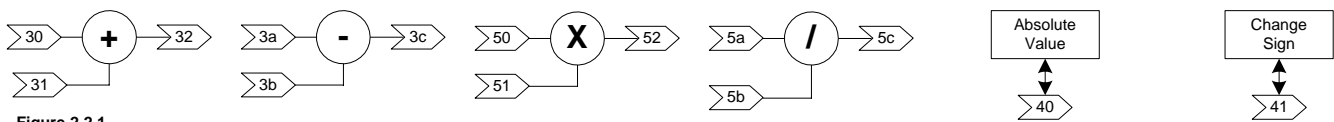

Figure 2.2.1

Math functions are used to convert numbers as indicated by the function blocks. These functions may be used more than one time in a configuration. The following equations are used.

Addition: Input 30 + Input 31 = Output 32

Subtraction: Input 3a – Input 3b = Output 3c

It is important to know that the multiplication and division operations are not standard. The scale function can be used for true multiplication and division.

Multiplication: (Input 50 X Input 51) / 10000 = Output 52
 Division: (Input 5a X 10000) / Input 5b = Output 5c
 Absolute Value: |Input 40| = Output 40
 Change Sign: Input 41 X -1 = Output 41

2.2.2 Compare

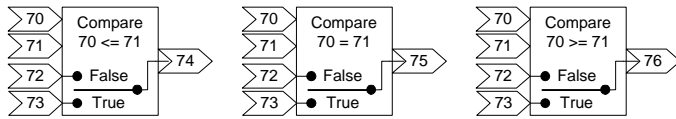

Figure 2.2.2

Compare functions compare the value connected to input 70 to the value connected to input 71. A true operation will output the value connected to input 73. A false operation will output the value connected to input 72. The output number used determines the compare operation. This operation may be used more than one time in a configuration. This function is a single function with three possible outputs.

2.2.4 PID

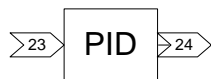

Figure 2.2.4

The PID function is a PID controller. Input connector 23 to this function must be connected to the error to correct for. This function can only be used one time in a configuration. It may not be used with the standard drive PID since many of the same parameters are used for tuning. B5-01 must be set to disabled.

Function	Controls	Range	Default	Setup
PID	B5-02 PID Gain = P Gain	0.00 to 25.00	1.00	B5-01 PID Mode = Disabled
	B5-03 PID I Time = I Bld Rate	0.00 to 360.00 sec	1.00	
	B5-04 PID I Limit = I Limit	0.0 to 100.0 %	100.0	
	B5-05 PID D Time = D Rate	0.00 to 100.0 sec	0.00	
	B5-06 PID Limit = Output Limit	0.0 to 100.0 %	100.0	

2.2.5 Scale

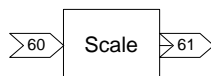

Figure 2.2.5

The scale operation functions to scale the value input. This function uses standard multiplication and division. It can be used for those operations and can be used more than once in a configuration. The following equation is used;

$$\text{output 61} = ((\text{input 60} \times \text{P1-08}) / \text{P1-09}) + \text{P1-10}$$

Function	Controls	Range	Default	Setup
Scale	P1-08 = Scale Multiplier	-9999 to 9999	0	
	P1-09 = Scale Divisor	-9999 to 9999	0	
	P1-10 = Scale Bias	-9999 to 9999		

2.2.6 Center Winder

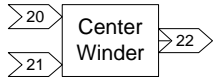

Figure 2.2.6

The Center Winder Function calculates and outputs the ratio of line surface speed / winder motor speed. This ratio can then be divided into the winder's speed reference to control the winder motor as the roll diameter increases or decreases. The actual roll diameter can be calculated by multiplying the ratio by the core diameter. The diameter will be in the same units as the core diameter. This is a simple center winder function and can be used only one time in a configuration.

Input connector 20 should connect to the line speed. The line speed must be directly related to the actual speed of the material being wound. Input connector 21 must be connected to the winder's motor speed. When the winder is at core input 20 should equal input 21. The necessary adjustments must be made to make this a true statement.

The output to this function is filtered to avoid over reacting to sudden short changes in the input information. Parameter P1-06 controls how fast the drive reacts to the diameter change. Parameter P1-07 sets the maximum ratio that will be applied to the drive speed and is equal to maximum roll diameter / core diameter. The ratio calculation will stop at the maximum ratio.

Function	Controls	Range	Default	Setup
Center Winder	P1-06 = Diameter Filter Time	0.1 to 50.0 sec	0.1	P1-07 = Max Roll Diameter / Core Diameter
	P1-07 = Diameter Build Ratio	0.1 to 15.0	12.5	

2.2.7 Switch

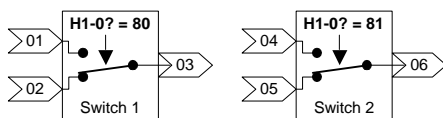

Figure 2.2.7

The switch function provides a means to switch between two possible inputs via a multi-function input. Switch 1 connects input 02 to output 03 when the multi-function input is off or not configured. Switch 1 connects input 01 to output 03 when the configured multi-function input is turned on. Switch 2 connects input 05 to output 06 when the multi-function input is off or not

configured. Switch 2 connects input 04 to output 06 when the configured multi-function input is turned on.

These functions can be used more than one time in a configuration but all instances will switch when the associated multi-function input is activated.

Function	Controls	Range	Default	Setup
Switch 1	Input 01 Normally Open			Terminal ? - H1-01 to 06 = 80: Switch 1 DI
	Input 02 Normally Closed			
Switch 2	Input 04 Normally Open			Terminal ? - H1-01 to 06 = 81: Switch 2 DI
	Input 05 Normally Closed			

2.2.8 Number Hold

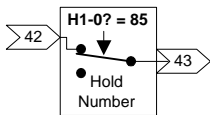

Figure 2.2.8

The number hold function will pass the input value to the output when the associated multi-function input is off. The last value read is held and output to 43 when the multi-function input is turned on. The hold value is stored in running memory not NVRAM. It will be lost when the drive is turned off.

Function	Controls	Range	Default	Setup
Number Hold	Input 42 connected to output 43			Terminal ? - H1-01 to 06 = 85: Number Hold

2.3 Drive

The Drive functions provide a means to direct information into the drive. Information can be directed to all drive outputs and monitors.

2.3.1 Drive Speed

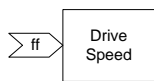

Figure 2.3.1

The Drive Speed function sends the value input directly to the drive's speed reference.

2.3.2 Drive Max Torque

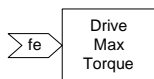

Figure 2.3.2

The Drive Maximum Torque function sets or dynamically changes the maximum forward and reverse torque value used by the drive. This control is only available when A2-01 = 3: flux vector control mode. The forward and reverse torque values are equal when this function is used.

2.3.3 Accel / Decel

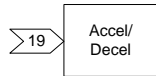

Figure 2.3.3

The Accel / Decel function allows the acceleration and deceleration rates to be dynamically adjusted. The change may be calculated using the following equations when the input is fixed.

$$\text{Accel Time} = (\text{Input } 19 \times \text{C1-01}) / 10000$$

$$\text{Decel Time} = (\text{Input } 19 \times \text{C1-02}) / 10000$$

When the input is 100.00% or 10000 the accel / decel rate will be C1-01 and C1-02.

2.3.4 Drive Output (contact and transistors)

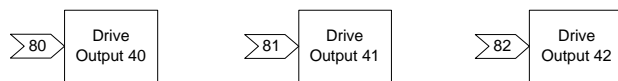

Figure 2.3.4

Drive Output functions provide control to the three multi-function outputs. When the value connected to the input exceeds the associated P2 parameter level the output will close. It will open when the input drops below the set level.

Function	Information	Setup
Contact Output 9	Connects terminal 9 to 10	H2-01 = 40: CONNECTION 80, P2-07: Output 9 Level
Trans Output 25	Sinks terminal 25 to 27	H2-02 = 41: CONNECTION 81, P2-08: Output 25 Level
Trans Output 26	Sinks terminal 26 to 27	H2-03 = 42: CONNECTION 82, P2-09: Output 26 Level

2.3.5 Monitor / Analog Output

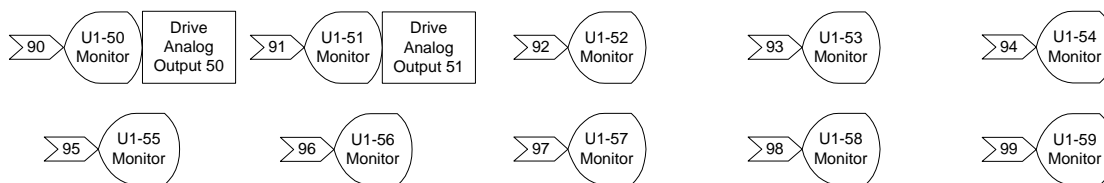

Figure 2.3.5

Monitor functions provide a means to monitor values within a configuration. They can be used at any time. Monitor functions do not require setup. The value input into a monitor is divided by 10, to increase the range of the monitor's display.

The drive's analog outputs can be connected to monitor U1-50 and U1-51. This feature must be setup. The displayed value will be sent to the associated analog output. Setting the connected analog output gain to 10 will provide the actual value connected to the monitor. The analog output will operate within the defined range. The gain and bias parameters can be used to scale the analog output.

Function	Information	Setup
Monitor 1 (U1-50)	Information can be passed to analog output terminals 21 and 23	H4-01 or H4-04 = 50: Case Monitor 1
Monitor 2 (U1-51)		H4-01 or H4-04 = 51: Case Monitor 2

2.3.6 Write Memory

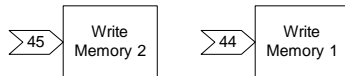

Figure 2.3.6

Write Memory functions allow values to be stored into memory. The last value input is stored in running memory not NVRAM. This number can be read using the corresponding Read Memory function. This function serves as a means to end and store the final value of a function's output. This number value can be reintroduce into the control logic where needed by using the Read Memory function. If the input of the Read Memory function is used before the corresponding Write Memory function in the configuration sequence the value read will be from the previous scan. This feature can be used to determine the change from scan to scan.

3.0 Parameter Changes

3.1 Group A User Parameters

The user parameters are located within the “Initialize” menu selection. When the GPD515/G5 drive has been flashed with this software A2-11 through A2-32 constants are converted to the parameters used to configure the drive.

3.2 Group b Applications – Function b1 Sequence

Display	Constant	Setting	Display	Description
Reference Source	b1-01	05	Eliminator Ref	Enables the Eliminator Software

3.3 Group H Terminal - Function H1 Digital Inputs

Display	Constant	Setting	Display	Description
Terminal 3 Sel Terminal 4 Sel Terminal 5 Sel Terminal 6 Sel Terminal 7 Sel Terminal 8 Sel	H1-01 H1-02 H1-03 H1-04 H1-05 H1-06	80	Switch 1 DI	Switch function with a common output to a NO and NC input
		81	Switch 2 DI	Switch function with a common output to a NO and NC input
		82	MOP UP	Increases the MOP value
		83	MOP DOWN	Decreases the MOP value
		84	MOP RESET	Resets the MOP value to the default value set in parameter P2-05
		85	Number Hold	Holds the last value input until de-activated
		86	CASE DI 7	Reserved
		87	CASE DI 8	Reserved

3.4 Function H2 Digital Outputs

Display	Constant	Setting	Display	Description
Terminal 9 Sel	H2-01	40	CONNECTION 80	Switch function with a common output to a NO and NC input
Terminal 25 Sel	H2-02	41	CONNECTION 81	Switch function with a common output to a NO and NC input
Terminal 26 Sel	H2-03	42	CONNECTION 82	Increases the MOP value

3.5 Function H4 Analog Outputs

Display	Constant	Setting	Display	Description
Terminal 21 Sel	H4-01	50	Case Monitor 1	Links the value in U1-50 to the selected analog output
Terminal 23 Sel	H4-04	51	Case Monitor 2	Links the value in U1-51 to the selected analog output

3.6 Group F Options

Constant F1-01, Pulses Per Rev is enabled in all control methods

4.0 Startup Procedure

1. Develop a configuration list.
2. Connect all external devices.
3. Perform the appropriate procedure for a standard drive startup.
4. Enter the configuration list into the User Parameters starting at A2-11.
5. Set the reference source to "Eliminator Ref" (**b1-01 = 5**).
6. Test the configuration using care to prevent damage to connected loads.

5.0 Custom Software Parameters

5.1 New Program Group

Group P Eliminator Parm

5.2 New Program Function

Function P1 Eliminator P1

Select Eliminator P1 to access parameters P1-01 to P1-10.

Function P2 Eliminator P2

Select Eliminator P2 to access parameters P2-01 to P2-10.

5.3 New Program Parameters

Parameter 1 P1-01 = 0

Setting Range: 0 to 65535
Factory Default: 0
Modify During Run: Yes
Modbus Address: 0580H

P1-01	Parameter 1	B	B	B	B
-------	-------------	---	---	---	---

This parameter is provided for user input. Refer to section 2.1.3.

Parameter 2 P1-02 = 0

Setting Range: 0 to 65535
Factory Default: 0
Modify During Run: Yes
Modbus Address: 0581H

P1-02	Parameter 2	B	B	B	B
-------	-------------	---	---	---	---

This parameter is provided for user input. Refer to section 2.1.3.

Parameter 3
P1-03 = 0

Setting Range: 0 to 65535
Factory Default: 0
Modify During Run: Yes
Modbus Address: 0582H

P1-03	Parameter 3	B	B	B	B
-------	-------------	---	---	---	---

This parameter is provided for user input. Refer to section 2.1.3.

Parameter 4
P1-04 = 0

Setting Range: 0 to 65535
Factory Default: 0
Modify During Run: Yes
Modbus Address: 0583H

P1-04	Parameter 4	B	B	B	B
-------	-------------	---	---	---	---

This parameter is provided for user input. Refer to section 2.1.3.

Parameter 5
P1-05 = 0

Setting Range: 0 to 65535
Factory Default: 0
Modify During Run: Yes
Modbus Address: 0584H

P1-05	Parameter 5	B	B	B	B
-------	-------------	---	---	---	---

This parameter is provided for user input. Refer to section 2.1.3.

Diam Filter Time
P1-06 = 0.1 sec

Setting Range: 1 to 50 sec
Factory Default: 0.1 sec
Modify During Run: No
Modbus Address: 0585H

P1-06	Diameter Filter Time	B	B	B	B
-------	----------------------	---	---	---	---

The Diam Filter Time controls the rate of change within the winder filter. Refer to section 2.2.6.

Diam Bld Ratio
P1-07 = 0.1

Setting Range: 0.1 to 50
Factory Default: 0.1
Modify During Run: No
Modbus Address: 0586H

P1-07	Diameter Build Ratio	B	B	B	B
-------	----------------------	---	---	---	---

The Diam Build Ratio is the number equal to the ratio of core diameter to maximum roll diameter. Refer to section 2.2.6.

Example:

Core Diameter = 4"
Max Roll Diameter = 48"
Set P1-07 = 48" / 4" or 12

Scale Multiplier
P1-08 = 0

Setting Range: -9999 to 9999
Factory Default: 0
Modify During Run: Yes
Modbus Address: 0587H

P1-08	Scale Multiplier	B	B	B	B
-------	------------------	---	---	---	---

The Scale Multiplier number is multiplied times the value of input 60. Refer to section 2.2.5.

Scale Divisor
P1-09 = 0

Setting Range: -9999 to 9999
Factory Default: 0
Modify During Run: Yes
Modbus Address: 0588H

P1-09	Scale Divisor	B	B	B	B
-------	---------------	---	---	---	---

The Scale Divisor is the number divided into the product of the scale multiplication. Refer to figure 2.2.5.

Scale Bias
P1-10 = 0

Setting Range: -9999 to 9999
Factory Default: 0
Modify During Run: Yes
Modbus Address: 0589H

P1-10	Scale Bias	B	B	B	B
-------	------------	---	---	---	---

The Scale Bias is the number that will be added to the value of the scale calculation to offset the value of output 61 up or down. Refer to section 2.2.5.

Max Pulses In
P2-01 = 30720

Setting Range: 0 to 65535
Factory Default: 30720
Modify During Run: Yes
Modbus Address: 0590H

P2-01	Max Pulses Input	B	B	B	B
-------	------------------	---	---	---	---

The Max Pulses In is the number that equals the input pulse rate per second that will result in 100 % inverter output. Refer to section 2.1.4.

Example: $30720 = (1800 \text{ rpm} \times 1024 \text{ encoder pulses per rev}) / 60 \text{ sec}$ (30720 is the default)

MOP Rate / Sec
P2-02 = 0.00 %

Setting Range: 0.01 to 100.00 %
Factory Default: 0.00 %
Modify During Run: Yes
Modbus Address: 0591H

P2-02	MOP Rate / Second	B	B	B	B
-------	-------------------	---	---	---	---

The MOP Rate / Sec sets the rate of MOP change for output 25. This number will be added to or subtracted from the current value of output 25 when the multi-function input assigned to 82

MOP UP or 83 MOP DOWN is energized for 5ms. Maintaining this input will result in output 25 changing at this rate per second. Refer to section 2.1.2.

<p>MOP Max Percent P2-03 = 100 %</p>

Setting Range: 0 to 1000 %
 Factory Default: 100 %
 Modify During Run: Yes
 Modbus Address: 0592H

P2-03	MOP Maximum Percentage	B	B	B	B
-------	------------------------	---	---	---	---

The MOP Max Percent sets the maximum MOP value possible for outputs 25 and 26. Refer to section 2.1.2.

<p>MOP Min Percent P2-04 = 0 %</p>

Setting Range: -1000 to 100 %
 Factory Default: 0 %
 Modify During Run: Yes
 Modbus Address: 0593H

P2-04	MOP Minimum Percentage	B	B	B	B
-------	------------------------	---	---	---	---

The MOP Min Percent sets the minimum MOP value possible for outputs 25 and 26. Refer to section 2.1.2.

<p>MOP Rst Percent P2-05 = 0 %</p>

Setting Range: -1000 to 1000 %
 Factory Default: 0 %
 Modify During Run: Yes
 Modbus Address: 0594H

P2-05	MOP Reset Percentage	B	B	B	B
-------	----------------------	---	---	---	---

The MOP Rst Percent is the value that outputs 25 and 26 are reset to when the multi-function input assigned to 84 MOP RESET is energized. Refer to section 2.1.2.

<p>MOP Step Rate P2-06 = 0.00 %</p>
--

Setting Range: 0.00 to 100.00
 Factory Default: 0.00
 Modify During Run: Yes
 Modbus Address: 0595H

P2-06	MOP Step Rate	B	B	B	B
-------	---------------	---	---	---	---

The MOP Step Rate is the number that will be added to or subtracted from the current value of output 26 when the multi-function input assigned to 82 MOP UP or 83 MOP DOWN is energized for 5ms. Each transition of either input will result in one step. Refer to section 2.1.2.

Out 9 Level
P2-07 = 0

Setting Range: -9999 to 9999
Factory Default: 0.00
Modify During Run: Yes
Modbus Address: 0596H

P2-07	Output 9 level	B	B	B	B
-------	----------------	---	---	---	---

The Out 9 Level sets the value that connection 80 must exceed to activate multi-function selection 40: CONNECTION 80. It is recommended that H2-01 Terminal 9 Sel be setup as 40: CONNECTION 80. This value is multiplied by 10 within the software. Refer to section 2.3.4

Out 25 Level
P2-08 = 0

Setting Range: -9999 to 9999
Factory Default: 0
Modify During Run: Yes
Modbus Address: 0597H

P2-08	Output 25 Level	B	B	B	B
-------	-----------------	---	---	---	---

The Out 25 Level sets the value that connection 81 must exceed to close multi-function selection 41: CONNECTION 81. It is recommended that H2-02 Terminal 25 Sel be setup as 41: CONNECTION 81. This value is multiplied by 10 within the software. Refer to section 2.3.4

Out 26 Level
P2-09 = 0

Setting Range: -9999 to 9999
Factory Default: 0
Modify During Run: Yes
Modbus Address: 0598H

P2-09	Output 26 Level	B	B	B	B
-------	-----------------	---	---	---	---

The Out 26 Level (x10) sets the value that connection 82 must exceed to activate multi-function selection 42: CONNECTION 82. It is recommended that H2-03 Terminal 26 Sel be setup as 42: CONNECTION 82. This value is multiplied by 10 within the software. Refer to section 2.3.4.

Max Torque Ref
P2-10 = 0.00 %

Setting Range: 0.00 to 300.00 %
Factory Default: 0.00 %
Modify During Run: Yes
Modbus Address: 0599H

P2-10	Maximum Torque Reference	B	B	B	B
-------	--------------------------	---	---	---	---

The Max Torque Ref value is the limit applied to input 'fe' of the drive maximum torque function. This is a bipolar limit and limits the torque output of the drive to this value. The values set in the L7 torque limiting constants remain in effect. Refer to section 2.3.2.

6.0 New Monitors

Monitor 1
U1-50 0.0

Range: -3276 to 3276.7 (x10)
Modbus Address: 00d0H

Monitor 1 will display the value / 10 of the output connected to input 90. When this monitor is used with the analog output function the displayed number is output.

Monitor 2
U1-51 0.0

Range: -3276 to 3276.7 (x10)
Modbus Address: 00d1H

Monitor 2 will display the value / 10 of the output connected to input 91. When this monitor is used with the analog output function the displayed number is output.

Monitor 3
U1-52 0.0

Range: -3276 to 3276.7 (x10)
Modbus Address: 00d2H

Monitor 3 will display the value / 10 of the output connected to input 92.

Monitor 4
U1-53 0.0

Range: -3276 to 3276.7 (x10)
Modbus Address: 00d3H

Monitor 4 will display the value / 10 of the output connected to input 93.

Monitor 5
U1-54 0.0

Range: -3276 to 3276.7 (x10)
Modbus Address: 00d4H

Monitor 5 will display the value / 10 of the output connected to input 94.

Monitor 6
U1-55 0.0

Range: -3276 to 3276.7 (x10)
Modbus Address: 00d5H

Monitor 6 will display the value / 10 of the output connected to input 95.

Monitor 7
U1-56 0.0

Range: -3276 to 3276.7 (x10)
Modbus Address: 00d6H

Monitor 7 will display the value / 10 of the output connected to input 96.

Monitor 8
U1-57 0.0

Range: -3276 to 3276.7 (x10)
Modbus Address: 00d7H

Monitor 8 will display the value / 10 of the output connected to input 97.

Monitor 9
U1-58 0.0

Range: -3276 to 3276.7 (x10)
Modbus Address: 00d8H

Monitor 9 will display the value / 10 of the output connected to input 98.

Monitor 10
U1-59 0.0

Range: -3276 to 3276.7 (x10)
Modbus Address: 00d9H

Monitor 10 will display the value / 10 of the output connected to input 99.